



FiberLink® 7142 Series



**4 Channels of Composite Video and
8 Channels of Audio over one single
mode or multimode fiber**

**Installation and Operations
Manual**

Contents

Welcome	3
Features	3
Package Contents	3
Technical Specifications	
Model Part Number Specifications	4
General Specifications	4
Video Specifications	4
Audio Specifications	5
Operating Loss Budgets	6
Maximum Useable Distance	6
Installation Instructions	6
Audio Configuration (Transmitter)	7
Audio Configuration (Receiver)	7
Audio Wiring	8
Indicator LEDs	9
Operating Pointers	10
Troubleshooting	10
Maintenance and Repairs	11
Certifications	11

Welcome

Thank you for purchasing Artel Video Systems' FiberLink 7142 Series. The FiberLink 7142 Series transmits four channels of uncompressed composite video and eight channels of audio over a single fiber optic cable. The system provides 7 MHz bandwidth per video channel and is compatible with NTSC, PAL and SECAM video standards.

Audio bandwidth is 20 Hz to 20 kHz. The 7142 Series, consisting of two units, transmitter and receiver, is available for use with single or multimode fiber. Indicator LEDs continuously indicate the presence of video, audio and power signals. The system's wide operating temperature range makes it suitable for use in any indoor or protected outdoor environment.

Features

- Transmits over multimode or single mode fiber at 1310 nm
- No adjustments; processing and transmission
- 7 MHz video bandwidth
- Video channel is compatible with NTSC, PAL or SECAM video standards
- 18-bit audio sampling; 20 Hz to 20 kHz audio bandwidth
- Audio channels may be configured independently by the user to have either balanced or unbalanced inputs and outputs
- Indicator LEDs monitor video signals, audio signals and power
- Universal input internal power supply
- Compatible with FiberLink 8200 Series
- Unit stands 1 RU high. Rackmount ears are included

Package Contents

- One FiberLink 7142 or 7143
- This User's Manual
- Rackmount Ears
- Power Cable

Technical Specifications

Model Part Number Specification

Unit Type	Part Number
Transmitter	7142-S7
Receiver	7143-S7

General Specifications

LED Indicators	Power; Video Present (per channel); Audio Present (per channel)
Power	95-250 volts AC, 47-63 Hz 7142: 9.5 Watts, 32.41 BTU/hr 7143: 8.5 Watts, 29.00 BTU/hr
Operating Temperature Range	0o to +55o C
Optical Connectors	ST
Operating Wavelength	1310 nm
CWDM Capable	Yes, Contact Sales
Physical Size	1.75 H x 16.75 W x 10 D (inches) 44 H x 425 W x 254 D (mm)
Weight	5lbs; 2.2kg
MTBF	34,000 Hours
Compatibility	Compatible with FiberLink 8200 Series. Not compatible with FiberLink 7140 & 7141 products

Technical Specifications

Video Specifications

Number of channels	4
Video Bandwidth (per channel)	7 MHz (-3 dB)
Input/Output Impedance	75 Ohms
Normal Input/Output Voltage	1V p-p nom., 1.1V p-p max.
Differential Gain	1%
Differential Phase	0.5 degree typical
Signal-to-Noise Ratio	62 dB CCIR weighted typical
Video Connectors	BNC

Audio Specifications

Number of channels	8, balanced or unbalanced
Frequency Response (per channel)	20 Hz to 20 kHz (-3 dB)
Input Impedance	600 Ohms terminated; >24 k Ohms unterminated
Output Impedance	50 Ohms
Normal Input/Output Voltage	0 dBu nom., +10 dBu max.
Signal-to-Noise Ratio	85 dB
THD+N	0.1% typical
Audio Connectors	Screw terminal block
Switches	Dip switches to select input termination, balanced or unbalanced input/output. Selectable on a per-channel basis

Optical Loss Budget & Maximum Useable Distance

Fiber Type	Loss Budget	Distance
Single Mode Fiber	0-17 dB	48km
Multimode Fiber (62.5u)	0-17 dB	1.0km
Multimode Fiber (50u)	0-17 dB	1.3km

*Distance specifications are approximate and are not guaranteed.
Operating loss budget must not be exceeded.

Installation Instructions

The FiberLink 7142 Series of fiber optic transmission systems are ready for immediate use and do not require any special tools or equipment. However, an Optical Power Meter, such as the FiberLink 6615, can be useful in determining optical loss budgets during your systems design and maintenance.

The following instructions describe the typical installation procedure:

1. Connect the video sources to the video input BNC connectors on the transmitter unit.
2. (Optional) Connect your audio sources to the audio inputs on the transmitter unit.
3. Connect the video output cables to the video output BNC connectors on the receiver unit.
4. (Optional) Connect audio output cables to the audio outputs on the receiver unit.
5. Connect the fiber optic cable to the transmitter and receiver units.
6. Configure your audio preferences as described in the Audio Configuration section of this manual.
7. When power is applied, the green POWER LED should illuminate, indicating the presence of operating power. The Video and the Audio LEDs will give an indication as described in the Indicator LED's and Alarm Circuitry section of this manual.
8. The system should now be operational.













DANGER!

The transmitting element in the FiberLink 7142 transmitter unit contains a solid state Laser Diode located in the optical connector. This device emits invisible infrared electromagnetic radiation which can be harmful to human eyes. The radiation from this optical connector, if viewed at close range with no fiber optic cable connected to the optical connector, may be sufficient intensity to cause instantaneous damage to the retina of the eye. Direct viewing of this radiation should be avoided at all times!

Audio Configuration:

The FiberLink 7142 Series units have four four position DIP switches that are accessible from the front panel. Operation is as follows:

Audio Configuration Switch Settings (Transmitter - Input)			
Channel (Switch Position)	Balanced (600 Ohms)	Balanced (24k)	Unbalanced (24k)
Left Channel Controlled by Switches 1 & 2	 Switch 1 Down Switch 2 Up	 Switch 1 Down Switch 2 Down	 Switch 1 Up Switch 2 Up
Right Channel Controlled by Switches 3 & 4	 Switch 3 Down Switch 4 Up	 Switch 3 Down Switch 4 Down	 Switch 3 Up Switch 4 Up
Audio Configuration Switch Settings (Receiver - Output)			
Channel (Switch Position)	Balanced	Unbalanced	
Left Channel Controlled by Switch 3	 Switch 3 Down	 Switch 3 Up	
Right Channel Controlled by Switch 4	 Switch 4 Down	 Switch 4 Up	

Audio Wiring - Transmitter

Balanced

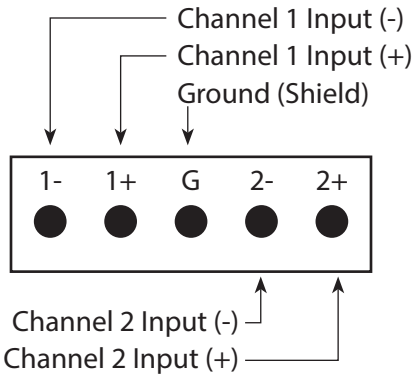

Unbalanced

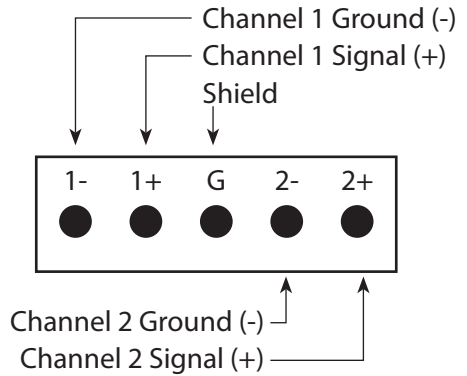

Audio Wiring - Receiver

Balanced

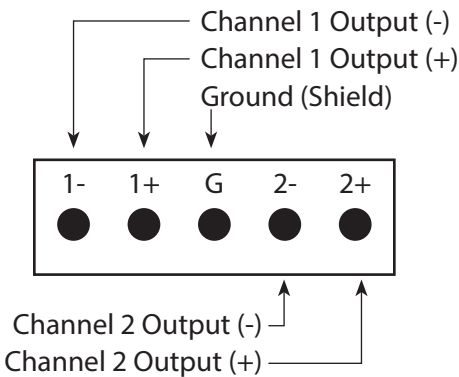

Unbalanced

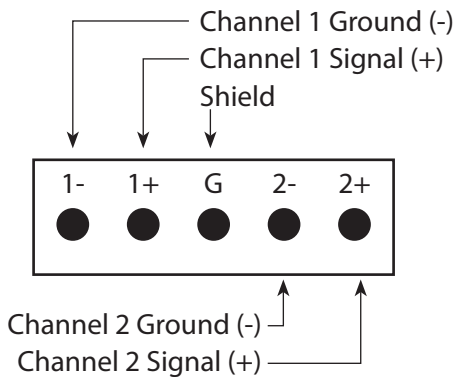

Indicator LEDs

The FiberLink 7142 Series has several indicator LEDs that are used to monitor the state of the unit. Each unit features one Power LED, 4 Video LEDs and 8 Audio LEDs, each corresponding to a specific channel. The LED's are as follows:

LEDs		
LED	Status	Definition
Power	On	Indicates that correct power has been applied.
Video	Off	Indicates that no video is present
	On	Indicates that video is present
Audio	Off	Indicates that no audio is present
	Blinking	Indicates that audio is present

Operating Pointers

Remember to check attenuation of the fiber optic cable. The system will only operate properly if these specifications fall within the range of the system's loss budget.

Troubleshooting

Multimode fiber optic cable contains an optical fiber with a light carrying "core" that is only .0025 inches (62.5 microns) in diameter. Single mode fiber optic cable has an even smaller "core," only .00032 to .0004 inches (8-10 microns). This is smaller than a human hair!

Therefore, any minute particles of dirt or dust can easily block the fiber from accepting or radiating light. To prevent this from happening, always use the provided dust caps when ever optical connectors are exposed to air. It is also a good idea to gently clean the tip of an optical connector with a lint-free cloth moistened with alcohol whenever dust is suspected.

The status of the LEDs should provide the first clue as to the origin of any operational failure. If these are off, it usually means that the fiber is broken or has too much attenuation.

Next, be certain that the input and output signal connections are correct.

An optical power meter, such as the FiberLink 6650, a visible light source, such as the FiberLink 6656, and a Three Wavelength Light Source, such as the FiberLink 6654, can greatly assist and expedite troubleshooting of fiber optic transmission systems and are recommended tools all installers should have available.

Finally, although multimode and single mode devices may look the same, they will not operate properly together. Using the wrong device or fiber can easily add more attenuation than specified, resulting in poor overall performance. It should be noted that some of our fiber optic products support both single mode and multimode fiber in the same unit.

If, after reviewing the above possibilities, the system is still not operating, please contact the Customer Service Department for further assistance. If you suspect your problem is caused by the optics or the fiber optic cable, and you have an optical power meter, please take the appropriate measurements prior to contacting support.

Maintenance and Repairs

The FiberLink 7142 Series has been manufactured using the latest semiconductor devices and techniques that electronic technology has to offer. They have been designed for long, reliable and trouble-free service and are not normally field repairable.

Should difficulty be encountered, Artel Video Systems maintains a complete service facility to render accurate, timely and reliable service of all products.

The only maintenance that can be provided by the user is to ascertain that optical connectors are free of dust or dirt that could interfere with light transmission and that electrical connections are secure and accurate. Please see the Troubleshooting section of this manual for additional information.

An optical power meter, such as the FiberLink 6650, a visible light source, such as the FiberLink 6656, and a Three Wavelength Light Source, such as the FiberLink 6654, can greatly assist and expedite troubleshooting of fiber optic transmission systems and are recommended tools all installers should have available.

All other questions or comments should be directed to our Customer Service Department. It should be noted that many “problems” can easily be solved by a simple telephone call.

If you suspect your problem is caused by the optics or the fiber optic cable, and you have an optical power meter, please take the appropriate measurements prior to contacting support.

Certifications



Proven Products, Unrivalled Service, and Great Support



- High performance plug and play products
- Stand alone and card cage versions available
- Solutions for most video, audio, and data formats
- Multimode and single mode versions
- Designed and manufactured in the USA
- Training and installation support available
- 24x7x365 technical support available



Artel Video Systems Corp.
5B Lyberty Way,
Westford, MA 01886 USA
T: 978-263-5775
F: 978-263-9755
sales@artel.com
customercare@artel.com
www.artel.com

All specifications subject to
change without notice. ©2016
Updated 07/31/2016
CS200-129614-00_F