



FiberLink® 5012 Series



Universal Data Transceiver Installation and Operations Manual

Contents

Welcome	3
Features	3
Package Contents	3
Quick Installation	4
Technical Specifications	
Model Part Number Specifications	5
Operation Theory	6
Installation Instructions	7
Signal and Power Connections	8
DIP Switch Settings	10
Configuring a ring or loop data bus	17
Operating Pointers	17
Troubleshooting	19
Maintenance and Repairs	20
Accessories and Related Products	22

Welcome

Thank you for purchasing Artel Video Systems' FiberLink 5012. The 5012 transmits and receives all standard data-related signals in accordance with EIA specifications. The 5012 is suitable for simplex, full duplex and drop-and-repeat operation, making it ideal for data acquisition, intelligent transportation, industrial, and manufacturing applications.

Features

- Transmits and receives all standard data-related signals in accordance with EIA specifications
- May be easily user-configured for the desired protocol, including mixed protocols
- Transmitter and receiver may be configured differently
- Adjustment free; all digital processing and transmission
- Wide operating data rate, with low-speed mode (DC up to 2.1 mbps; 200 Kbps for RS-232) and high-speed mode (10 Kbps - 10 mbps)
- Extended ambient operating range
- Data-derived or RTS transmit/receive switching (RS-485)
- Indicator LEDs monitor signal and power
- Card version fills one slot in 6000A card cage
- RoHS Compliant

Package Contents

- One FiberLink 5012
- This User's Manual

Quick Installation Guide

The following is a *quick installation guide* for the 5012 model. It is intended for users familiar with the installation of fiber optic transmission systems to get “up and running” in minimal time. Since these units are capable of being configured for operation in many different modes, we strongly suggested that you consult the appropriate sections of this manual.

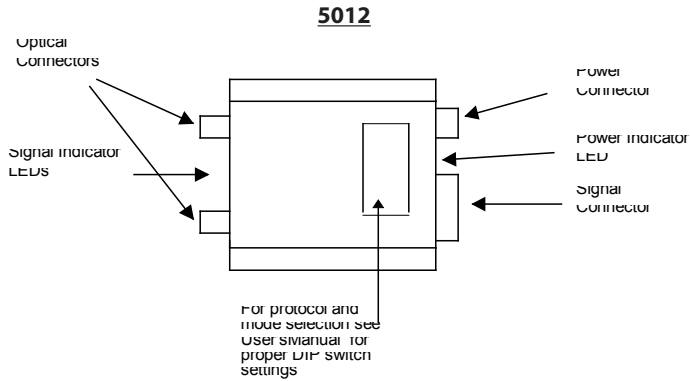

General Information

The Universal Data Transceiver is fully compatible with EIA standards for RS-232, RS-422 and RS-485 at data rates from 0 (DC) to 2.1 mbps (200 kbps for RS-232) in the low speed mode or from 10 kbps to 10 mbps in the high speed mode. It may be used for simplex or full duplex asynchronous transmissions in both point-to-point systems and drop-and-repeat data networks. It may also be used as a protocol converter. Although there are no operating controls, the user must configure the unit for the protocol, speed and mode of operation desired.

The universal data transceiver comes in two versions, the 5012 stand-alone model and the 5018A card-cage model. The two models are fully compatible with each other.

Technical Specifications

Model Part Number Specification

System Protocols*	EIA RS-232, RS-422, RS-485, 2-wire or 4-wire		
System Data Rate*	Low speed:	RS-232, DC-200 kbps, RS-422/485, DC to 2.1 mbps	
	High speed:	RS-422/485, 10 kbps to 10 mbps	
Modes of Operation*	Simplex, duplex, drop-and-repeat, Asynchronous, RTS or Data Derived T/R control		
Operating Wavelength	850 nm or 1310 nm		
Optical Connectors	ST (MM) or FCPC (SM)		
Operating Temperature	-35 to +75 degrees C		

Wavelength	Loss Budget (dB)	Distance (km)	Loss Budget (dB)	Distance (km)
	Low Speed	Low Speed	High Speed	High Speed
850 MM	0-12	0-4	0-6	0-2
1310 MM	0-14	0-14	0-8	0-8
1310 SM	0-15	0-35	0-8	0-20

* Note that as provided from the factory, the universal data transceiver is set to the RS-232 point-to-point (200 kbps) and low speed modes of operation. In the low speed mode the unit will operate with all duty cycles including DC (logic 0 or logic 1 continuously). In the high speed mode of operation, the system will operate properly with all duty cycles from 50-50% to 70-30%.

Theory of Operation

The transmitting section of the universal data transceiver converts an incoming RS-232, RS-422 or RS-485 signals into pulses of light at the transmitting LED located in the “Transmit (or Tx)” optical connector on the unit. These pulses of light equate to ON for a positive input level and OFF for a negative or zero input level.

The receiving section of the universal data transceiver produces a user selectable RS-232, RS-422 or RS-485 compatible output from the received light at the photodiode located in the “Receive (or Rx)” optical connector on the unit. Due to the fact that all internal logic signals are converted to either light-on or light-off, any protocol may be used in conjunction with any other protocol, thereby allowing the transceiver to be used as a data converter as well as a general data transceiver. In addition, provision is incorporated to allow drop and repeat operation with any protocol.

During normal operation, the RTS line (terminal block position 6) is not used. In external RTS operation (for RS-485), terminal block position 6 is used as an enable input to toggle the unit between transmit and receive. In this mode a positive input switches the unit to the transmit mode while a zero input switches the unit to the receive mode. As an alternative, the unit may be automatically switched from transmit to receive by means of an internal data-driven timer (Data-Derived T/R switching).

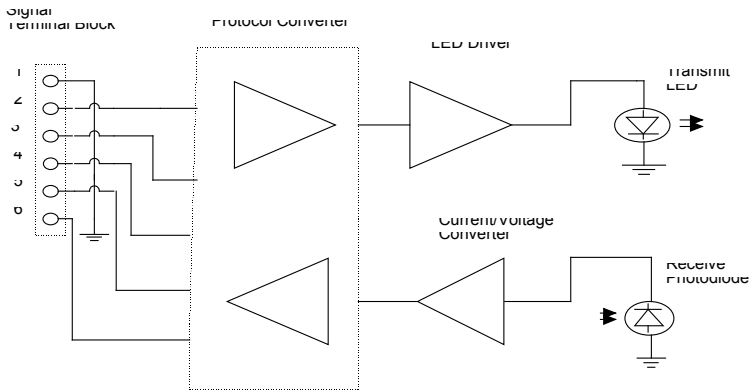

UNIVERSAL DATA TRANSCEIVER BLOCK DIAGRAM

Installation instructions

There are no operating controls on the universal data transceiver. Simply set the mode of operation with the internal DIP switches and then connect the signal, power supply and fiber optic cables between the two units.

1. Connect the data processing equipment to be used to the 6 position terminal block on the 5012 . *Refer to the signal and power connections section on page 6 for specifics.* Be certain that the various connections are made properly. Also be sure to only use the positions called out for any particular protocol.
2. Set the internal DIP switches for the protocol, speed and mode of operation according to the instructions beginning on page 8. *Note: As provided from the factory, the unit is set for RS-232, point-to-point.*
3. Connect operating power (+10 to +18 VDC). Refer to Figure 1 for DC power connections.
4. Connect the 5012 units together with two conductor fiber optic cable. Be certain that the “Transmit” connector of one unit is connected to the “Receive” connector of the other unit.
5. The system should now be operational.

Figure 1:
5012 Power Connector
DC Input Polarity

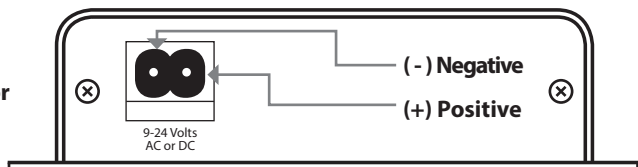

DANGER!

The transmitting element in the FiberLink 5012 transmitter unit contains a solid state Laser Diode located in the optical connector. This device emits invisible infrared electromagnetic radiation which can be harmful to human eyes. The radiation from this optical connector, if viewed at close range with no fiber optic cable connected to the optical connector, may be sufficient intensity to cause instantaneous damage to the retina of the eye. Direct viewing of this radiation should be avoided at all times!

The transmitting element in the “-7” single mode version of the universal data transceiver uses a solid state Laser Diode located in the “Transmit” or “Tx” optical connector on the unit. This device emits invisible infrared electro-magnetic radiation which, if viewed at close range without a fiber optic cable connected to the optical connector, may be of sufficient intensity to cause instantaneous damage to the retina of the eye. As a result, direct viewing of this radiation should be avoided at all times.

Signal and Power Connections

The power terminal block connections for the model 5012 are as follows: +10 to +18 VDC, position 2. DC return, position 1. Note that this input is also reverse-polarity protected.

RS-232 Signal Connections:

Description	EIA Designation	Terminal Positions
Chassis Ground/Common	(AA)	1
Transmit Data	(BA) (input)	2
Receive Data	(BB) (output)	4
Signal Common	(AB)	1

All other terminal block positions should not be connected for this format.

RS-422 Signal Connections:

Chassis Ground		1
Transmit Data (+)	(input)	2
Transmit Data (-)	(input)	3
Receive Data (+)	(output)	4
Receive Data (-)	(output)	5

All other terminal block positions should not be connected for this format.

RS-485 2-Wire Signal Connections:

Chassis Ground		1
Transmit/Receive Data (+)	(input/output)	2
Transmit/Receive Data (-)	(input/output)	3
RTS Enable (when used)	(input)	6

All other terminal block positions should not be connected for this format.

RS-485 4-Wire Signal Connections:

Chassis Ground		1
Transmit Data (+)	(input)	2
Transmit Data (-)	(input)	3
Receive Data (+)	(output)	4
Receive Data (-)	(output)	5
RTS Enable (when used)	(input)	6

All other terminal block positions should not be connected for this format.

When the RTS mode of operation is used, the input to terminal 6 must be "high" for the unit to transmit data and "low" to receive data.

Modes of Operation:

On the 5012 stand-alone model of the universal data transceiver, there are two internal DIP switches which are accessible on the bottom of the housing. These must be set to configure the desired mode of operation.

Setting the MODE DIP switch

Switch setting example

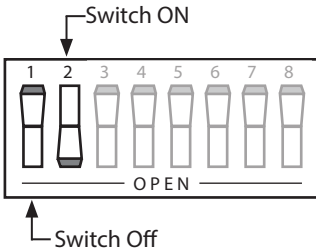

For all protocols, positions 1 and 2 of the MODE DIP switch should be set as follows:

- Low speed mode (DC to 2.1 mbps):
Position 1 = ON, Position 2 = OFF

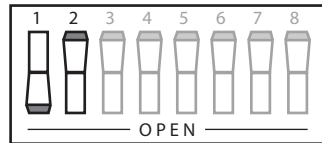

- High speed mode (10 kbps to 10 mbps):
Position 1 = OFF, Position 2 = ON

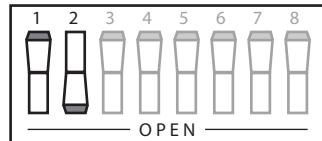

*For RS-232, the data rate is limited to 200 kbps. For RS-422/485, the data rate is as above.
The universal data transceiver will not operate properly if positions 1 and 2 are both set to either ON or OFF.*

Use the following protocol-specific settings to finish configuring the MODE DIP switch on your universal data transceiver.

RS-232 Point-to-Point (Factory-Default Setting)

See speeds
on pg 10

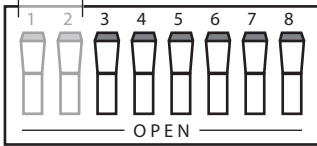

Mode

All Off

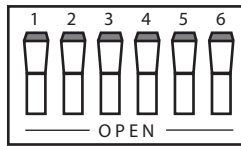

T/R

RS-232 Drop-and-Repeat

See speeds
on pg 10

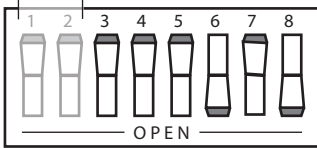

Mode

All Off

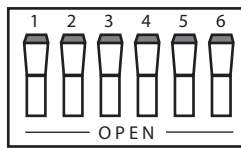

T/R

When using this mode of operation, any RS-232 driver not transmitting data must be in the low or - voltage state as per EIA RS-232D.

RS-422 Point-to-Point

See speeds
on pg 10

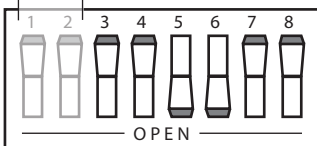

Mode

All Off

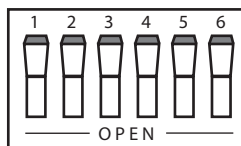

T/R

No end-of-line terminating resistors are provided. If required, they must be connected externally.

RS-422 Drop-and-Repeat

See speeds
on pg 10

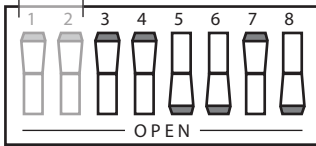

Mode

All Off

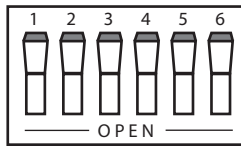

T/R

No end-of-line terminating resistors are provided. If required, they must be connected externally. When using this mode, any RS-422 driver not transmitting data must be in the “low” state (terminal block position 2, negative with respect to position 3).

RS-485 2-Wire Point-to-Point RTS Enable

See speeds
on pg 10

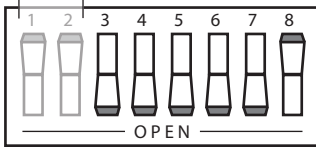

Mode

All Off

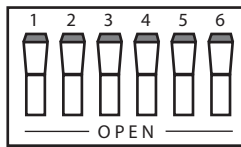

T/R

In this mode, the input to terminal 6 must be “high” for the unit to transmit data and “low” to receive data. No end-of-line terminating resistors are provided. If required, they must be connected externally.

RS-485 2-Wire Drop-and-Repeat RTS Enable

See speeds
on pg 10

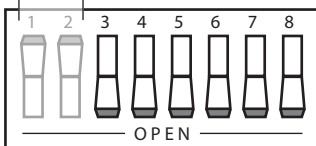

Mode

All Off

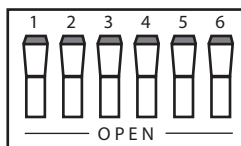

T/R

In this mode, the input to terminal 6 must be “high” for the unit to transmit data and “low” to receive data. No end-of-line terminating resistors are provided. If required, they must be connected externally.

RS-485 2-Wire Point-to-Point Data Derived T/R

See speeds
on pg 10

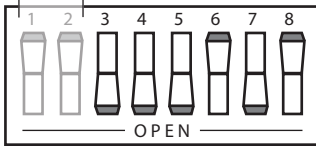

Mode

See baud rate
settings on pg 15

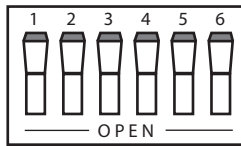

T/R

After transmitting the last data bit, the above settings will determine how long the transceiver continues to wait in the transmit mode for data before reverting to the receive state. The times specified are only recommendations but will be correct for most applications. If desired, they can be varied to meet specific data requirements. No end-of-line terminating resistors are provided. If required, they must be connected externally.

RS-485 2-Wire Drop-and-Repeat Data Derived T/R

See speeds
on pg 10

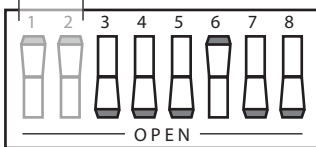

Mode

See baud rate
settings on pg 15

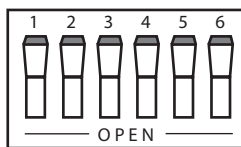

T/R

After transmitting the last data bit, the above settings will determine how long the transceiver continues to wait in the transmit mode for data before reverting to the receive state. The times specified are only recommendations but will be correct for most applications. If desired, they can be varied to meet specific data requirements. No end-of-line terminating resistors are provided. If required, they must be connected externally.

RS-485 4-Wire Point-to-Point RTS Enable

See speeds
on pg 10

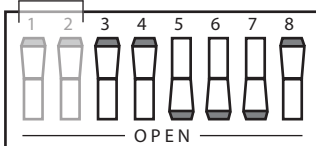

Mode

All Off

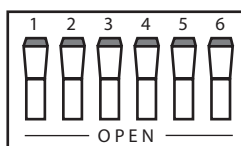

T/R

In this mode, the input to terminal 6 must be "high" for the unit to transmit data and "low" to receive data. No end-of-line terminating resistors are provided. If required, they must be connected externally.

RS-485 4-Wire Drop-and-Repeat RTS Enable

See speeds
on pg 10

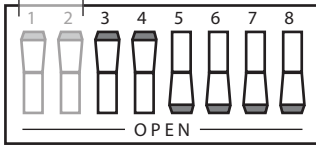

Mode

All Off

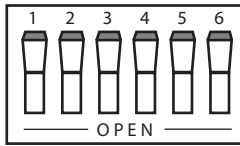

T/R

In this mode, the input to terminal 6 must be “high” for the unit to transmit data and “low” to receive data. No end-of-line terminating resistors are provided. If required, they must be connected externally.

RS-485 4-Wire Point-to-Point Data-Derived T/R

See speeds
on pg 10

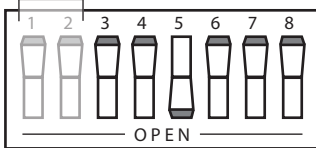

Mode

See baud rate
settings on pg 15

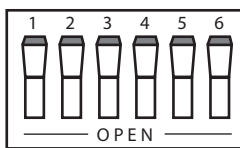

T/R

After transmitting the last data bit, the above settings will determine how long the transceiver continues to wait in the transmit mode for data before reverting to the receive state. The times specified are only recommendations but will be correct for most applications. If desired, they can be varied to meet specific data requirements. No end-of-line terminating resistors are provided. If required, they must be connected externally.

RS-485 4-wire Drop-and-Repeat Data-Derived T/R

See speeds
on pg 10

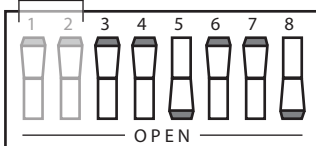

Mode

See baud rate
settings on pg 15

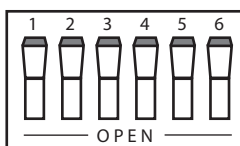

T/R

After transmitting the last data bit, the above settings will determine how long the transceiver continues to wait in the transmit mode for data before reverting to the receive state. The times specified are only recommendations but will be correct for most applications. If desired, they can be varied to meet specific data requirements. No end-of-line terminating resistors are provided. If required, they must be connected externally.

Baud Rate Settings (T/R Time 6 position switch)

Baud Rate	T/R Time	1	2	3	4	5	6
2400	4.73 ms	Off	Off	Off	Off	Off	On
4800	2.20 ms	Off	Off	Off	Off	On	Off
9600	1.10 ms	Off	Off	Off	On	Off	Off
19.2K	620 us	Off	Off	On	Off	Off	Off
38.4K	300 us	Off	On	Off	Off	Off	Off
57.6K	180 us	On	Off	Off	Off	Off	Off
76.8K	150 us	On	Off	On	On	Off	Off
115.2K	110 us	On	On	On	Off	Off	Off

2400

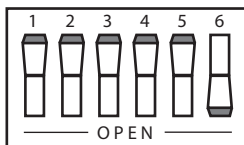

4800

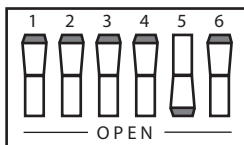

9600

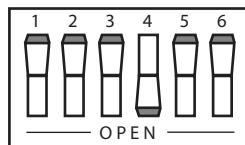

19.2k

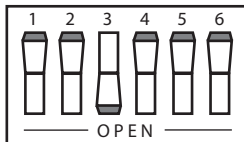

38.4k

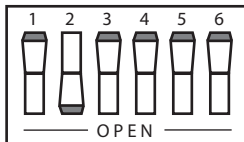

57.6k

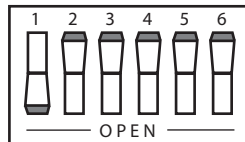

76.8k

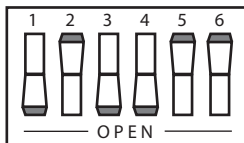

115.2k

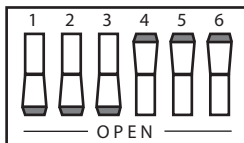

Optical Fiber

Versions of the universal data transceiver are available to drive most multimode (MM) and single-mode (SM) optical fibers. The specific models are identified by a suffix at the end of the model numbers as follows:

Fiber Size	Connector	850nm	1310nm
50 μ , 62.5 μ MM	ST	-1	-3
8/10 μ SM	FCPC	N/A	-7

A 6300 adapter is available to allow the -1 and -3 versions of the 5012 model to be used with multimode fiber and SMA connectors. A 6310 adapter is available to allow the -7 versions of these models to be used with single-mode fiber and single-mode ST connectors.

Indicator LEDs

The 5012 model has three green signal indicator LEDs that continuously monitor operation. One, labeled “Power (or PWR)”, lights when operating power is present. The other two, labeled “Transmit (or Tx)” and “Receive (or Rx)”, turn on whenever the transmitted or received data is in the “high” state and off when it is in the “low” state. As a result, they actually blink at the rate of the operating data. However, most data rates are so fast that these LEDs will usually appear to be on continuously.

Configuring a ring or loop-type data bus

In addition to point-to-point transmissions, the universal data transceiver can be used to implement a ring or loop-type data bus. This is accomplished by setting the internal DIP switches as shown in the following diagram.

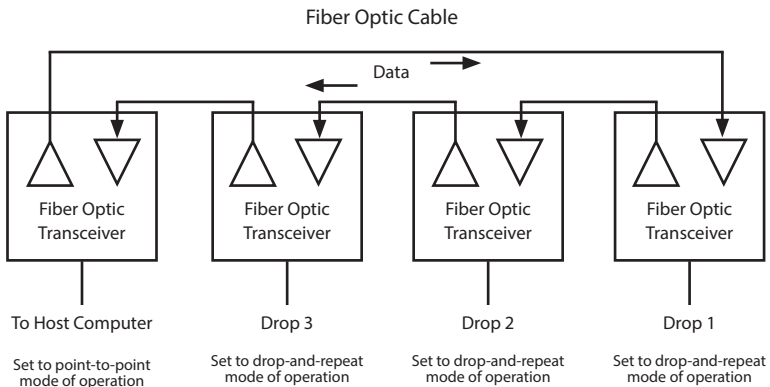

Ring or Loop-type Data Bus Configuration

When the universal data transceiver is used in this mode, any location can receive or insert data into the ring/loop but only one station at a time is permitted to insert data. All other stations will receive the data but **must** maintain their individual input lines in the low state (RS-232, terminal block position 2 negative with respect to position 1; RS-422, terminal block position 2, negative with respect to position 3) to prevent loop lock-up. RS-485 operation does not have the above restriction due to the fact that it is in the tri-state mode when not transmitting.

Note that the first (or host) location is set to the point-to-point mode. All other locations are set to the drop-and-repeat mode. This is to prevent loop lock-up or data "echos".

Operating considerations for fiber optic cable

The universal data transceiver may be supplied with ST or FCPC type optical connectors and will operate with most common fiber optic cables. However, it is important to use the correct type of fiber optic cable as required by your particular transceiver model. Some models (ending in -1 and -3) are designed for use at 850 nm, while others (ending in -7) function at 1310 nm.

When using any type of fiber optic cable, be careful not to cause excessive strains, especially at the cable-to-connector junctions. Also, do not subject the cable to sharp bends or pull it around sharp corners. Whenever possible, service loops or extra slack should be provided in any installation. While excessive precautions are not necessary, fiber optic cable should be treated with moderate care as it does contain thin, fragile strands of glass.

Notes Regarding Fiber Optic Cable

Multimode fiber optic cable contains an optical fiber with a light carrying “core” that is only .0025 inches (62.5 μ) diameter. Single-mode fiber optic cable has an even smaller “core”, only 00032 to .0004 inches (8-10 μ). This is smaller than a human hair! Any minute particle of dirt or dust can easily block this fiber from accepting or radiating light. *As a result, the key word is cleanliness.* Always use the dust caps provided with all optical connectors whenever they are exposed to air. Also, it is a good idea to gently clean the tip of an optical connector with alcohol whenever dust is suspected.

Mechanical butt splices or optical feedthroughs must be installed properly. Multimode devices will not operate properly with single-mode devices even though they may look the same. Using the wrong device can easily add more attenuation than specified, resulting in impaired performance.

Operating Pointers

Remember to check attenuation of the fiber optic cable. The system will only operate properly if these specifications fall within the range of the system’s loss budget.

Troubleshooting

If your system is not operating properly, the following checklist may help to diagnose the problem:

A. Check Transmitter or Transmit Section of a Transceiver

1. Is operating power (DC, AC, Voltages) correct?
2. Are you using the correct pins on the connector or terminal block?
3. Is the correct signal level present at transmitter input?
4. Is the optical connector on the transmitting LED clear of any obstruction or minute dirt particles?
5. Is there a short circuit anywhere in the system due to common power ground, signal ground and case?

B. Check Optical Connectors

1. Are the connectors the correct size for the fiber?
2. Are the ends of the connectors free of all dust or dirt? If not, gently clean the tip of the connector with a clean cloth or gauze moistened with alcohol.
3. Is the fiber broken in the connector? A quick inspection with an inexpensive jeweler's loop can determine this.
4. Is the fiber protruding from the tip of the connector? If so, refinishing will be necessary.

C. Check Fiber Optic Cable

1. Is the fiber optic cable pulled too tightly around a sharp corner?
2. Is the correct fiber size being used with the correct transmitter/receiver combination?
3. Does the fiber pass light at all? A small penlight or flashlight can usually be used for this test.
4. Does the fiber have too much attenuation for the system? The attenuation measured on the installed cable will always be different than when the cable was still on the reel.
5. When using lengths shorter than 10 meters (30 feet), overloading of the receiver may occur. The shorter the length of the fiber, the greater the possibility for this condition. Be sure there is adequate attenuation in any system. For very short distances, contact the factory for assistance.

D. Check Receiver or Receiving Section of a Transceiver

Follow the same steps as for checking the Transmitter.

Maintenance and Repairs

The FiberLink 5012 Series has been manufactured using the latest semiconductor devices and techniques that electronic technology has to offer. They have been designed for long, reliable and trouble-free service and are not normally field repairable.

Should difficulty be encountered, Artel Video Systems maintains a complete service facility to render accurate, timely and reliable service of all products.

The only maintenance that can be provided by the user is to ascertain that optical connectors are free of dust or dirt that could interfere with light transmission and that electrical connections are secure and accurate. Please see the Troubleshooting section of this manual for additional information.

An optical power meter, such as the FiberLink 6650, a visible light source, such as the FiberLink 6656, and a Three Wavelength Light Source, such as the FiberLink 6654, can greatly assist and expedite troubleshooting of fiber optic transmission systems and are recommended tools all installers should have available.

All other questions or comments should be directed to our Customer Service Department. It should be noted that many “problems” can easily be solved by a simple telephone call.

If you suspect your problem is caused by the optics or the fiber optic cable, and you have an optical power meter, please take the appropriate measurements prior to contacting support.

Certifications





FiberLink 6656 Visible Fault Locator

The FiberLink 6656 is a light-weight, hand-held tool used to quickly troubleshoot faults in the continuity of both single-mode and multimode fibers. High-intensity visible laser allows for visible fault location of breaks and microbends in both single-mode and multimode fibers.



FiberLink 6650 Optical Power Meter

The FiberLink 6650 Optical Power Meter is a high accuracy, high resolution, microprocessor controlled optical power meter. 65 dB dynamic range; calibrated to measure 850, 1300, 1310 and 1550nm. Works with multimode and single mode fiber. Graphical LCD display with intuitive user interface with simple 2-key operation.



FiberLink 6654 Dual Wavelength Single Mode Light Source

The FiberLink Light Source offers a laser output at selectable wavelengths, allowing for convenient, on-site testing of fiber networks during construction and maintenance procedures.

Proven Products, Unrivalled Service, and Great Support



- High performance plug and play products
- Stand alone and card cage versions available
- Solutions for most video, audio, and data formats
- Multimode and single mode versions
- Designed and manufactured in the USA
- Training and installation support available
- 24x7x365 technical support available



Artel Video Systems Corp.
5B Lyberty Way,
Westford, MA 01886 USA
T: 978-263-5775
F: 978-263-9755
sales@artel.com
customercare@artel.com
www.artel.com

All specifications subject to
change without notice. ©2016
Updated 07/31/2016
CS200-120151-00_S