



# FiberLink® 3394 Series



**Bi-directional 3G/HD/SD-SDI  
Transmission with two way audio,  
data, 10/100 Ethernet & contact  
closure over one or two fibers.**

**Installation and Operations  
Manual**

## Contents

Model Part Number Specification .....	4
General Specifications .....	4
Data Specifications .....	4
Audio Specifications .....	5
Ethernet Specifications .....	5
Contact Closure Specifications .....	6
FiberLink 3394 Series Transmitter Section Specifications .....	6
FiberLink 3394 Series Receiver Section Specifications .....	7
Operating Loss Budget .....	8
Maximum Useable Distance .....	8
Installation Instructions .....	8
Installation Instructions (cont.) .....	9
Audio Wiring - Inputs .....	10
Audio Wiring - Outputs .....	10
Reference Photos - Box Front/Rear .....	10
Audio Input Switch Settings For Box Versions .....	11
Audio Output Switch Settings For Box Versions .....	11
Data Configuration For Box Versions .....	11
Ethernet Configurations For Box Versions .....	12
Baud Rate Configuration For Box Versions .....	12
Data Wiring For Box Versions .....	13
Contact Closure Wiring For Box Versions .....	13
Reference Photos - Card .....	14
Audio Input Switch Settings For Card Version .....	14
Audio Output Switch Settings For Card Version .....	15
Data Configuration For Card Version .....	15
Data Baud Rate Configuration For Card Versions .....	16
Ethernet Configurations For Card Version .....	17
Data Wiring For Card Versions .....	17
Contact Closure Wiring For Card Versions .....	17
Alarm Switch Settings & Options .....	18
Alarm Switch Settings (Card Version Only) .....	18
Indicator LEDs .....	19
Operating Pointers .....	20
Troubleshooting .....	20
Maintenance and Repairs .....	21
Accessories and Related Products .....	22

## Welcome

Thank you for purchasing Artel Video Systems' FiberLink 3394 Series. The 3394 Series is used to transmit bi-directional 3G/HD/SD-SDI, audio, 10/100 Ethernet, serial data, and contact closure over one or two fibers. The FiberLink 3394 series is compatible with single mode or multimode fiber. The system delivers noise-free transmission that retains all of the signals' initial parameters. The 3394 Series also provides immunity to video pathological signals over the entire link budget and operating temperature range.

## Features

- Transmit 2 bi-directional SDI channels (one each way)
- Transmit 4 channels of bi-directional audio (two each way)
- Transmit 1 channel of bi-directional RS-Type data
- Transmit 10/100 Base-T Ethernet
- Transmit 1 channel of bi-directional contact closure
- All channels are independent and available simultaneously
- SDI signal is equalized and re-clocked prior to fiber optic transmission
- Receiver features a re-clocked SDI output
- Immunity to pathological patterns over entire link budget and operating temperature range
- Compliant with SMPTE 259M-2006, 292-2006, 424M-2006, 276M
- Supports single mode and multimode fiber
- One fiber and two fiber versions available
- Supports 3G/HD/SD-SDI inputs with or without embedded audio and data
- 14 dB Optical Link Budget @ 2.97 Gbps
- Wide operating temperature range: -10° C to +50° C
- Available in Box and Card versions
- ST or LC connectors available
- Designed and manufactured in the USA by Artel

## Package Contents

- One FiberLink Unit (3394, 3395, 3396, 3397)
- This User's Manual
- One Ethernet Crossover Cable

## Model Part Number Specification

Unit Type	Part Number
Transceiver Box (1 Fiber, MM)	3394-B3z & 3395-B3z
Transceiver Rack Card (1 Fiber, MM)	3394-C3z & 3395-C3z
Transceiver Box (1 Fiber, SM)	3394-B7z & 3395-B7z
Transceiver Rack Card (1 Fiber, SM)	3394-C7z & 3395-C7z
Transceiver Box (2 Fibers, MM)	3396-B3z & 3397-B3z
Transceiver Rack Card (2 Fibers, MM)	3396-C3z & 3397-C3z
Transceiver Box (2 Fibers, SM)	3396-B7z & 3397-B7z
Transceiver Rack Card (2 Fibers, SM)	3396-C7z & 3397-C7z

**NOTE:** “z” = variable to identify the optical connector installed in the unit. We offer LC and ST connectors. The part number will indicate each by replacing “z” with “L” or “S”.

## General Specifications

Indicators	Power, SDI TX, SDI RX, Audio Activity, RS-Data Activity Ethernet LEDs on RJ-45 Connector Alarm (card version only)
Box Version Dimensions	6.5 W x 1.15 H x 8 L (inches) 165 W x 29 H x 203 L (mm)
Weight	approx. 1 lb.; 0.45 kg
Number of slots in 6000A card cage	2
Power	9-24 volts, AC or DC 3394/96: 7.5 watts, 25.6 BTU/Hr 3395/97: 7.5 watt s, 25.6 BTU/Hr
Operating Temperature	-10°C to +50°C

## Data Specifications

Data Channels	1 Channel, Bi-Directional
Data Bandwidth	DC to 115 Kb/sec, max.
Control Format	Switch selectable RS-232, RS-422 & RS-485 (4 wire or 2 wire)
Protocols	NRZ, NRZI, RZ, Manchester, Bi-phase
Signal Connector	Removable terminal block

## Audio Specifications

Number of Audio Channels	2, balanced or unbalanced, bi-directional
Bits per sample/ Sampling Rate	24 bits, 78 kHz
Audio Connector	Removable terminal block
Switches	<ul style="list-style-type: none"> <li>Select input termination</li> <li>Balanced or unbalanced input/output, selectable on a per-channel basis</li> </ul>
Frequency Response	+0/-0.5 dB, 20 Hz - 20 kHz
Maximum Audio Level	+10 dBu
Signal-to-Noise Ratio (A-weighted)	95 dB referenced full scale (balanced)
THD	0.002%, 20Hz - 20 kHz, full scale
Channel Phase Differential	$\pm 0.1^\circ$
Crosstalk	-100 dB (1kHz)
Audio Noise Level	-85 dBm
System Gain	Unity Gain, $\pm 3\%$ , input: balanced 600 Ohms, 50 Ohms source impedance ; output: balanced into 600 Ohms.
Input Impedance	600 Ohms terminated, >24K Ohms unterminated
Output Impedance	50 Ohms nominal
Audio to Video Diff. Delay (skew)	<300 usec

## Ethernet Specifications

Port	10/100 Base-T, RJ-45 connector, Configured as MDI
Speed	10 Mbps & 100 Mbps Ethernet, Switch Selectable

## Contact Closure Specifications

Contact Closure Input	Dry contact or TTL level referenced to GND
Contact Closure Output	Isolated reed relay contacts; 115 Volts AC; 50/60 Hz @ 0.2 A or 24 Volts DC @ 1 A
Contact Closure Connectors	Removeable terminal block

## FiberLink 3394 Series Transmitter Section Specifications

### Serial Video BNC Input Specifications

Number of Inputs	1
Data Bandwidth	19.4 Mbps to 2.97 Gbps
Supported Standards	SMPTE 259M, 292, 424M-2006, 305M 344M, DVB-ASI
Reclocked Data Rates	270 Mbps (SMPTE 259M, DVB-ASI-270), 1.485 Gbps (SMPTE 292), 2.97 Gbps (SMPTE 424M-2006)
Equalization	Automatic up to 100m of Belden 1694A at 2.97 Gbps, 200m at 1.485 Gbps and 350m at 270 Mbps
Return Loss	>10dB up to 2.97 Gbps

### Fiber Optic Output Specifications

Connector	LC or ST
Wavelengths Used 2-Fibers:	1310nm, 1490nm, 1550nm
Wavelengths Used 1-Fiber:	1510nm, 1530nm, 1550nm, 1570nm
Emmitter Type	Laser
Output Power ( <i>nominal</i> )	-3.0 dBm
SDI Re-clocking	At 270 Mbps, 1.485 Gbps & 2.97 Gbps

## FiberLink 3394 Series Receiver Section Specifications

### Serial Video BNC Output Specifications

Number of Outputs	1
Signal Level	800mV $\pm$ 10%
DC Offset	0V $\pm$ 0.5V
Rise/Fall Time	< 135 ps at 2.97 Gbps per SMPTE 424M; < 270 ps at 1.485 Gbps per SMPTE 292; 0.4 ns to 1.5 ns at 270 Mbps per SMPTE 259M
Overshoot	< 10% of amplitude
Timing Jitter	< 0.2 UI at 270 Mbps; < 1.0 UI at 1.485 Gbps; < 2.0 UI at 2.97 Gbps with color bar signal
Alignment Jitter	< 0.2 UI at 270 Mbps; < 0.2 UI at 1.485 Gbps; < 0.3 UI at 2.97 Gbps with color bar signal
Re-clocking	At 270 Mbps, 1.485 Gbps & 2.97 Gbps

### Fiber Optic Input Specifications

Connector	LC or ST
Wavelength	1100 - 1620 nm
Minimum Input Sensitivity	-17 dBm at 2.97 Gbps; -19 dBm at 1.485 Gbps -19 dBm at 270 Mbps;
Maximum Input Power	0 dBm

## Operating Loss Budget

Single Mode Fiber	0-14 dB at 2.97 Gbps
	0-16 dB at 1.485 Gbps
	0-16 dB at 270 Mbps
Multimode Fiber (62.5u)	0-14 dB at 2.97 Gbps
	0-16 dB at 1.485 Gbps
	0-16 dB at 270 Mbps
Multimode Fiber (50u)	0-14 dB at 2.97 Gbps
	0-16 dB at 1.485 Gbps
	0-16 dB at 270 Mbps

## Maximum Useable Distance

Single Mode Fiber	30 km at 2.97 Gbps
	40 km at 1.485 Gbps
	40 km at 270 Mbps
Multimode Fiber (62.5u)	0.8 km at 2.97 Gbps
	1 km at 1.485 Gbps
	2.5 km at 270 Mbps
Multimode Fiber (50u)	1 km at 2.97 Gbps
	1.3 km at 1.485 Gbps
	3 km at 270 Mbps

\*Distance specifications are approximate, based upon connecting a 3394 Transceiver to a 3395 Transceiver, and are not guaranteed. Artel cannot estimate or guarantee operating loss budgets when the 3394 Series is used with other, non-FiberLink devices. Operating loss budget must not be exceeded

## Installation Instructions

The FiberLink 3394 Series of fiber optic transmission systems are ready for immediate use and do not require any special tools or equipment.

### The following instructions describe the typical installation procedure:

- 1) Connect the video source to the video input BNC connector on the transceiver unit.
- 2) Connect the video output cable to the video output BNC connector on the transceiver unit.
- 3) Configure the audio and data preferences as described in the appropriate sections of this manual.
- 4) Connect the data connections as described in the Data Wiring section of this manual.
- 5) The Ethernet port is configured as an MDI port. If you are **not** connecting the 3394 Series to an auto-crossover Ethernet port, you may need to use the Ethernet crossover cable supplied with the unit to connect to another MDI port.
- 6) Connect the audio wiring as described in the Audio Wiring section of this manual.



## Installation Instructions (cont.)

- 7) Connect the contact closure wiring as described in the Contact Closure Wiring section of this manual.
- 8) Connect the fiber optic cable(s) to the transceiver units.  
**Note: when using the two-fiber version, you must connect transceiver “A” Optical 1 to transceiver “B” Optical 1 and transceiver “A” Optical 2 to transceiver “B” Optical 2.**
- 9) Connect the Universal Power Supply to the transceiver units.  
 For box versions using DC power, please refer to figure 1.
- 10) When power is applied, the green POWER LED should illuminate, indicating the presence of operating power. The 3G/HD/SD RATE, audio, and data LEDs will give an indication as described in the Indicator LED’s and Alarm Circuitry section of this manual.
- 11) The system should now be operational.

*Note: The Rack Card version has an additional red LED for indicating the presence of an alarm condition (loss of signal). Refer to Indicator LED’s and Alarm Circuitry sections of this manual.*

**Figure 1:**  
**Power Connector**  
**DC Input Polarity**

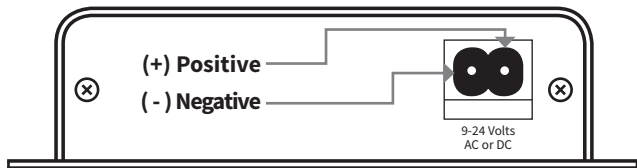

**DANGER!**

The transmitting element in the FiberLink 3394 transmitter unit contains a solid state Laser Diode located in the optical connector. This device emits invisible infrared electromagnetic radiation which can be harmful to human eyes. The radiation from this optical connector, if viewed at close range with no fiber optic cable connected to the optical connector, may be sufficient intensity to cause instantaneous damage to the retina of the eye. Direct viewing of this radiation should be avoided at all times!

**Audio Wiring - Inputs**

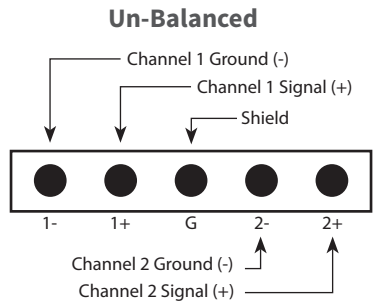
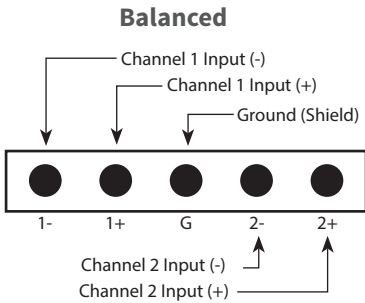



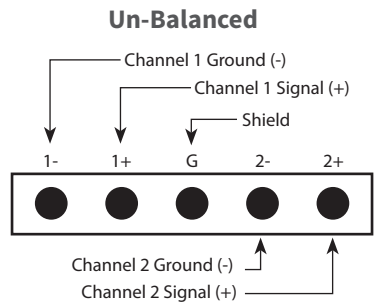
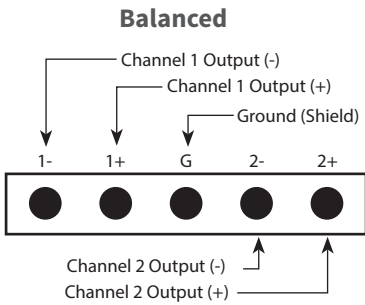

**Audio Wiring - Outputs**





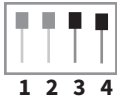

**Reference Photos - Box Front/Rear**



**Audio Input Switch Settings For Box Versions**

Channel #	Balanced (600 Ohms)	Balanced (24k Ohms)	Unbalanced (24k Ohms)
<b>Channel 1</b> (controlled by Switches 3 & 4)			
<b>Channel 2</b> (controlled by Switches 1 & 2)			

**Audio Output Switch Settings For Box Versions**

Channel #	Balanced	Unbalanced
<b>Channel 1</b> (controlled by Switch 2)		
<b>Channel 2</b> (controlled by Switch 1)		

**Data Configuration For Box Versions**

The FiberLink 3394 Series box units have three switch blocks; one 10 position, one 4 position, and one 2 position. The first block, “Data Config”, represents the Ethernet and RS Channel configurations.

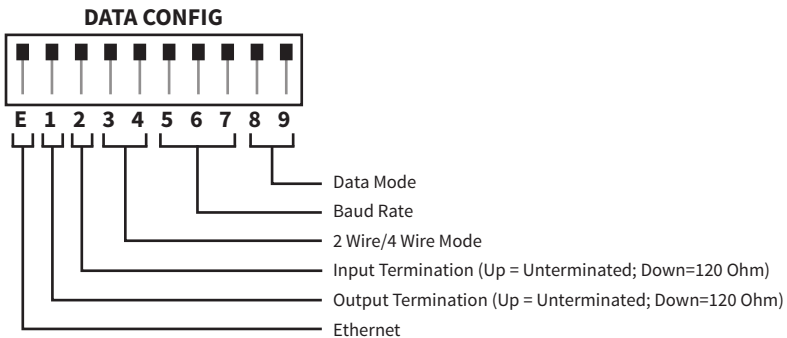

**Ethernet Configurations For Box Versions**

**DATA CONFIG**



E 1 2 3 4 5 6 7 8 9

**100 Base-T Ethernet**

**DATA CONFIG**

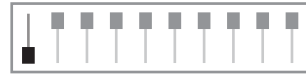

E 1 2 3 4 5 6 7 8 9

**10 Base-T Ethernet**

**Baud Rate Configuration For Box Versions**

**DATA CONFIG**



2400

E 1 2 3 4 5 6 7 8 9

**DATA CONFIG**



4800

E 1 2 3 4 5 6 7 8 9

**DATA CONFIG**



9600

E 1 2 3 4 5 6 7 8 9

**DATA CONFIG**



19.2k

E 1 2 3 4 5 6 7 8 9

**DATA CONFIG**

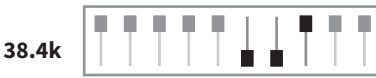

38.4k

E 1 2 3 4 5 6 7 8 9

**DATA CONFIG**

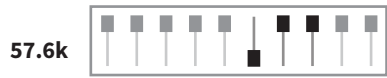

57.6k

E 1 2 3 4 5 6 7 8 9

**DATA CONFIG**



76.8k

E 1 2 3 4 5 6 7 8 9

RS-Data Configuration For Box Versions

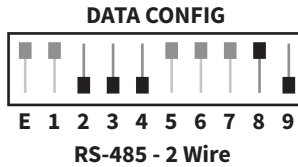
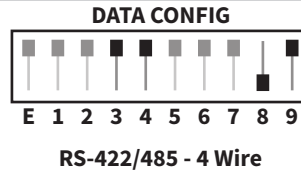
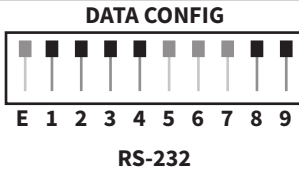

Data Wiring For Box Versions

**RS-232**



**RS-422/485 - 4 Wire**

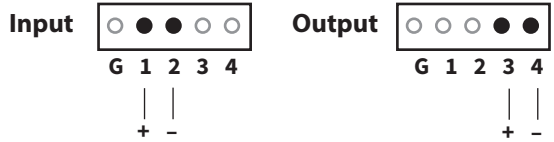

**RS-485 - 2 Wire**

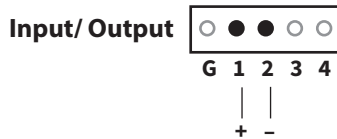

Contact Closure Wiring For Box Versions

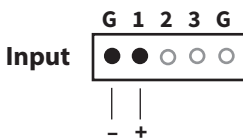





Reference Photos - Card



Audio Input Switch Settings For Card Version

Channel #	Balanced (600 Ohms)	Balanced (24k Ohms)	Unbalanced (24k Ohms)
<b>Channel 1</b> (controlled by Switches 1 & 2)	<p>1 2 3 4</p>	<p>1 2 3 4</p>	<p>1 2 3 4</p>
<b>Channel 2</b> (controlled by Switches 3 & 4)	<p>1 2 3 4</p>	<p>1 2 3 4</p>	<p>1 2 3 4</p>

**Audio Output Switch Settings For Card Version**

Channel #	Balanced	Unbalanced
<b>Channel 1</b> (controlled by Switch 1)	 1 2	 1 2
<b>Channel 2</b> (controlled by Switch 2)	 1 2	 1 2

**Data Configuration For Card Version**

The FiberLink 3394 Series card units have three switch blocks; one 10 position, one 4 position, and one 2 position. The first block, “Data Config”, represents the Ethernet and RS Channel configurations.

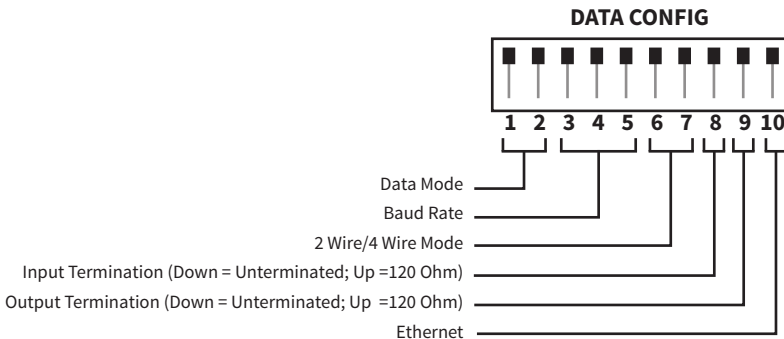

Data Baud Rate Configuration For Card Versions

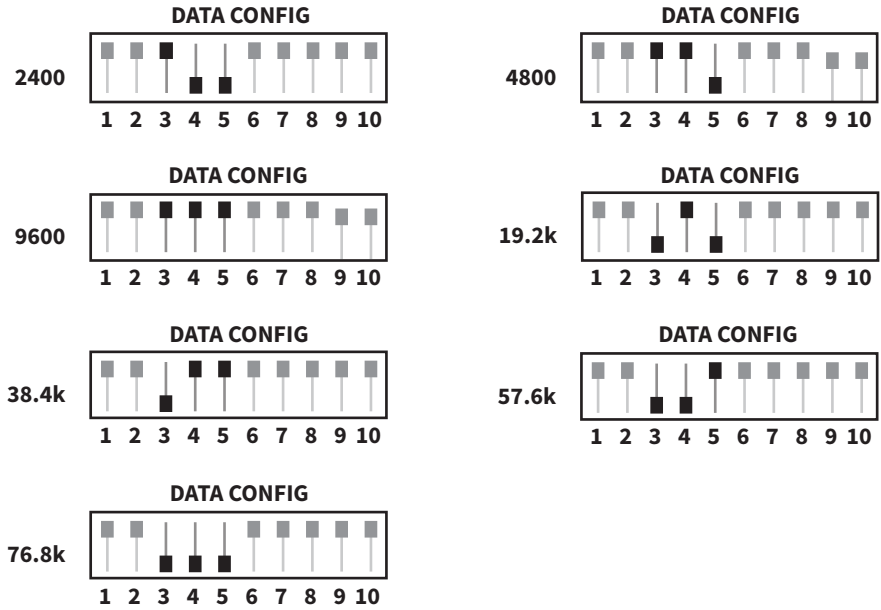

Data Configuration Switch Settings for Card Versions

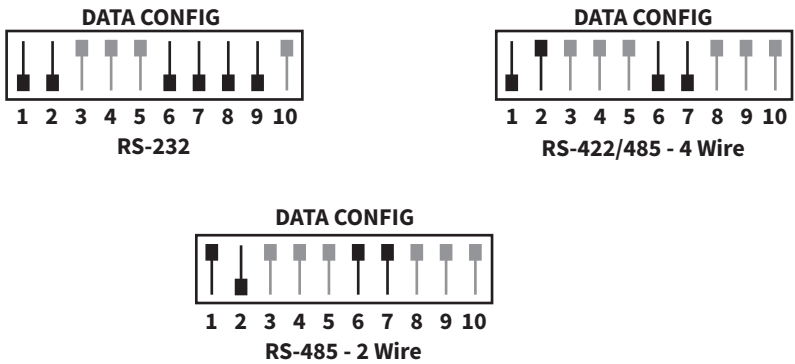



Ethernet Configurations For Card Version

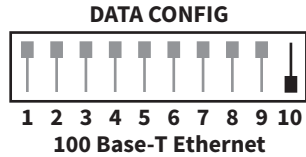
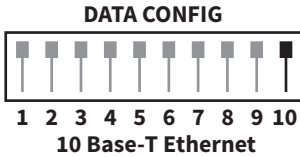

Data Wiring For Card Versions

**RS-232**

**Input**

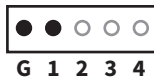

**Output**

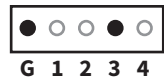

**RS-422/485 - 4 Wire**

**Input**

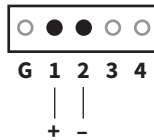

**Output**

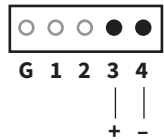

**RS-485 - 2 Wire**

**Input/Output**

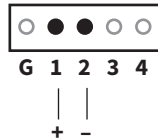

Contact Closure Wiring For Card Versions

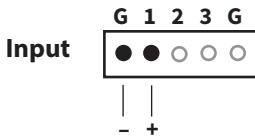

## Alarm Switch Settings & Options

The Rack Card version of this product has an additional red indicator LED that illuminates when an alarm condition exists.

The rack card unit also provides an output to drive a model 6020A Alarm Sensing Module which provides an audible tone and activates a set of contacts for external signaling purposes.

### Alarm Switch Settings (Card Version Only)

Switch Position	Alarm Indication	Up	Down
1	Loss of "Optical 1" for 1 Fiber Version	Enabled	Disabled
2	Loss of "Optical 2" for 2 Fiber Version	Enabled	Disabled
3	Loss of Receive Video	Enabled	Disabled
4	Loss of Transmit Video	Enabled	Disabled

## Indicator LEDs

The FiberLink 3394 Series has several indicator LEDs that are used to monitor the state of the unit. Card versions have an additional Alarm LED.

### Transceiver LED

LED	Status	Definition
Power	On	Indicates that correct power has been applied.
HD/3G TX	Off	Indicates no HD/3G-SDI data rate lock (electrical)
	On	Indicates HD/3G-SDI data rate lock at 1.485 Gbps or 2.97 Gbps
HD/3G RX	Off	Indicates no HD/3G-SDI data rate lock (optical)
	On	Indicates HD/3G-SDI data rate lock at 1.485 Gbps or 2.97 Gbps
SD TX	Off	Indicates no SD-SDI data rate lock (electrical)
	On	Indicates SD-SDI data rate lock at 270 Mbps
SD RX	Off	Indicates no SD-SDI data rate lock (optical)
	On	Indicates SD-SDI data rate lock at 270 Mbps
Audio In	Off	No audio input present (electrical)
	Blink	Audio input detected (electrical)
Audio Out	Off	No audio output present (optical)
	Blink	Audio output active (optical)
Data	Off	Indicates no data present (electrical or optical)
	Blink	Indicates data present (electrical or optical)
Alarm	On	Alarm Condition. (See Alarm Settings section, page 18)

*Note: The 3G, HD and SD LEDs indicators are off when a non-standard signal is applied.*

## Operating Pointers

Remember to check attenuation of the fiber optic cable. The system will only operate properly if these specifications fall within the range of the system's loss budget.

Note: If no electrical signals are applied to the Transceiver inputs, no optical power will be present on the Transceiver's optical output.

## Troubleshooting

Multimode fiber optic cable contains an optical fiber with a light carrying "core" that is only .0025 inches (62.5 microns) in diameter. Single mode fiber optic cable has an even smaller "core," only .00032 to .0004 inches (8-10 microns). This is smaller than a human hair! Therefore, any minute particles of dirt or dust can easily block the fiber from accepting or radiating light. To prevent this from happening, always use the provided dust caps when ever optical connectors are exposed to air. It is also a good idea to gently clean the tip of an optical connector with a lint-free cloth moistened with alcohol whenever dust is suspected.

The status of the LEDs should provide the first clue as to the origin of any operational failure. If these are off, it usually means that the fiber is broken or has too much attenuation.

Next, be certain that the input and output signal connections are correct.

An optical power meter, such as the FiberLink 6650, a visible light source, such as the FiberLink 6656, and a Two Wavelength Light Source, such as the FiberLink 6652/6654, can greatly assist and expedite troubleshooting of fiber optic transmission systems and are recommended tools all installers should have available.

Finally, although multimode and single mode devices may look the same, they will not operate properly together. Using the wrong device or fiber can easily add more attenuation than specified, resulting in poor overall performance. It should be noted that some of our fiber optic products support both single mode and multimode fiber in the same unit.

If, after reviewing the above possibilities, the system is still not operating, please contact the Customer Service Department for further assistance. If you suspect your problem is caused by the optics or the fiber optic cable, and you have an optical power meter, please

## Maintenance and Repairs

The FiberLink 3394 Series has been manufactured using the latest semiconductor devices and techniques that electronic technology has to offer. They have been designed for long, reliable and trouble-free service and are not normally field repairable.

Should difficulty be encountered, Artel Video Systems maintains a complete service facility to render accurate, timely and reliable service of all products.

The only maintenance that can be provided by the user is to ascertain that optical connectors are free of dust or dirt that could interfere with light transmission and that electrical connections are secure and accurate. Please see the Troubleshooting section of this manual for additional information.

An optical power meter, such as the FiberLink 6650, a visible light source, such as the FiberLink 6656, and a Two Wavelength Light Source, such as the FiberLink 6652/6654, can greatly assist and expedite troubleshooting of fiber optic transmission systems and are recommended tools all installers should have available.

All other questions or comments should be directed to our Customer Service Department. It should be noted that many “problems” can easily be solved by a simple telephone call.

If you suspect your problem is caused by the optics or the fiber optic cable, and you have an optical power meter, please take the appropriate measurements prior to contacting support.

---

Certifications





### FiberLink 6650 Optical Power Meter

The FiberLink 6650 Optical Power Meter is a high accuracy, high resolution, microprocessor controlled optical power meter. 65 dB dynamic range; calibrated to measure 850, 1300, 1310 and 1550nm. Works with multimode and single mode fiber. Graphical LCD display with intuitive user interface with simple 2-key operation.



### FiberLink 6652/6654 Light Sources

The FiberLink Light Source offers a laser output at selectable wavelengths, allowing for convenient, on-site testing of fiber networks during construction and maintenance procedures.



### FiberLink 6656 Visible Light Source

The FiberLink 6656 is a light-weight, hand-held tool used to quickly troubleshoot faults in the continuity of both single-mode and multimode fibers. High-intensity visible laser allows for visible fault location of breaks and micro-bends in both single-mode and multimode fibers



### FiberLink 6658

The FiberLink Optical Length Meter measures the length of both single mode and multimode fiber with accuracy of  $\pm 2.5$  meters. Generates a pulsed signal for use with fiber identifiers. Easy-to-read bright red 7-segment LED display. Comes equipped with industry preferred ST connectors.



## Proven Products, Unrivalled Service, and Great Support



- High performance plug and play products
- Stand alone and card cage versions available
- Solutions for most video, audio, and data formats
- Multimode and single mode versions
- Designed and manufactured in the USA
- Training and installation support available
- 24x7x365 technical support available



Artel Video Systems Corp.  
5B Lyberty Way,  
Westford, MA 01886 USA  
T: 978-263-5775  
F: 978-263-9755  
sales@artel.com  
customer@artel.com  
www.artel.com

All specifications subject to  
change without notice.  
©2016  
Updated 07/31/2016  
CS200-130115-00\_F